

# NPort® 5400 Series

## 4-port RS-232/422/485 serial device servers



- > 10/100M auto-sensing Ethernet
- > 4 serial ports supporting RS-232/422/485
- > Socket modes: TCP server/TCP client/UDP/Real COM
- > Configure via Telnet/Web/Windows utility
- > SNMP MIB-II for network management
- > 2 kV isolation protection for NPort 5430I/5450I/5450I-T
- > -40 to 75°C operating temperature range (T model)



### : Network-Readiness for up to Four Serial Devices

NPort® 5400 device servers can conveniently and transparently connect up to four serial devices to an Ethernet network, allowing you to network your existing serial devices with only basic configuration. Data transmission between the serial and Ethernet interfaces is

bi-directional. By using NPort® device servers, you not only protect your current hardware investment, but also allow for future network expansion. You can both centralize the management of your serial devices and distribute management hosts over the network.

### : Independent Operation Mode for Each Serial Port

NPort® 5400 device servers can be used to connect different devices for remote data polling or event handling over a TCP/IP network. Each serial port on the NPort® 5400 operates independently to provide

maximum versatility. For example, port 1 can operate in Driver mode, port 2 in TCP Server mode, and ports 3 and 4 in TCP Client mode.

### : User-friendly LCD Panel for Easy Installation

An LCD panel is built into the NPort® 5400's top panel, with four buttons for data input, configuration, and operation mode selection. The LCD panel displays the server name, serial number, and IP address, and it can be used to enter or modify parameters such as IP address, netmask, and gateway. (The LCD panel is not available on wide temperature models.)

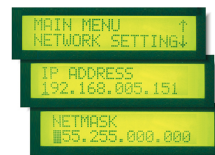

### : Dual DC Power Inputs

NPort® 5400 device servers support dual power sources by providing both a DC terminal block input and a DC power jack input. Providing two types of power inputs gives users greater flexibility for use with different applications.



### : Adjustable Termination and Pull High/Low Resistors

The NPort 5400 series provides adjustable termination and pull high/low resistors for RS-485 applications. In some critical environments, termination resistors may be needed to prevent the reflection of serial signals, and the pull high/low resistors may need adjusting to maintain the integrity of the electrical signal. Since no set of resistor values is universally compatible with all environments, the NPort® 5400 has four sets of DIP switches on the bottom panel to set the termination and pull high/low resistor values.

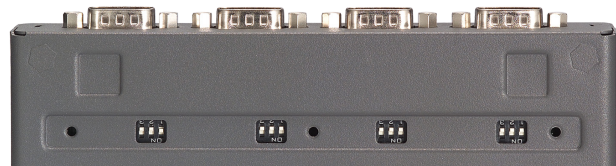

## Appearance

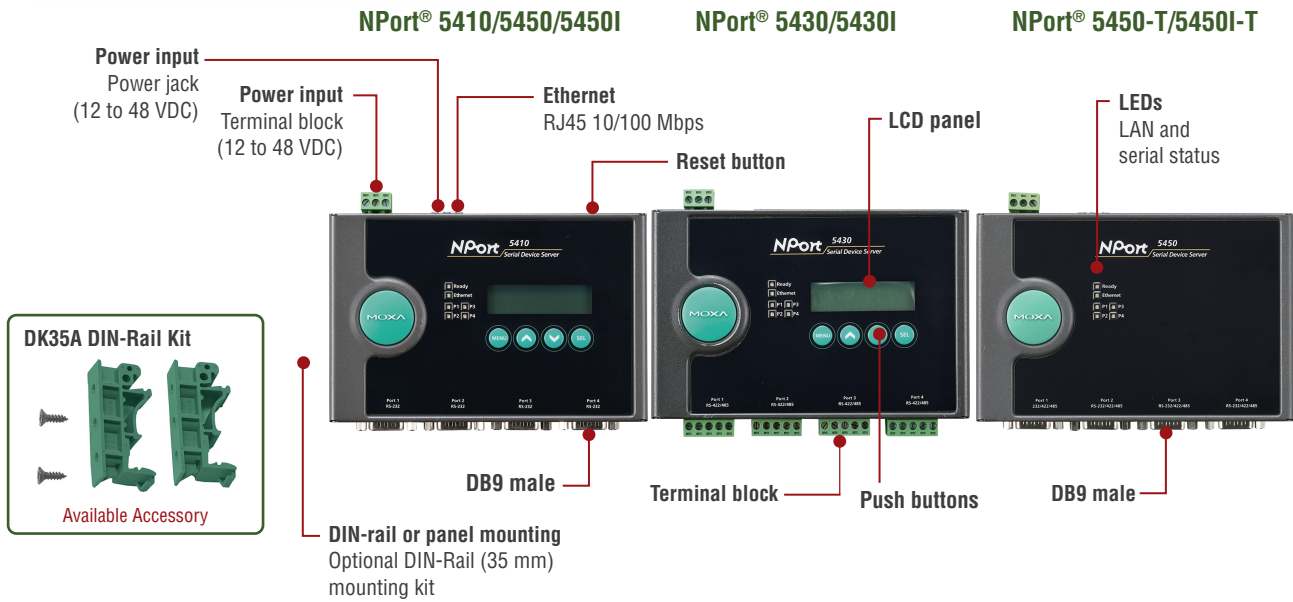

## Specifications

### Ethernet Interface

**Number of Ports:** 1  
**Speed:** 10/100 Mbps, auto MDI/MDIX  
**Connector:** 8-pin RJ45  
**Magnetic Isolation Protection:** 1.5 kV built-in

### Serial Interface

**Number of Ports:** 4  
**Serial Standards:**  
 NPort 5410: RS-232  
 NPort 5430/5430I: RS-422/485 (software selectable)  
 NPort 5450/5450I/5450-T/5450I-T: RS-232/422/485 (software selectable)  
**Connector:**  
 NPort 5410/5450/5450I/5450-T/5450I-T: DB9 male  
 NPort 5430/5430I: Terminal block  
**Serial Line Protection:**  
 2 kV isolation protection (NPort 5430I/5450I/5450I-T)  
**RS-485 Data Direction Control:** ADDC® (Automatic Data Direction Control)

**Pull High/Low Resistor for RS-485:** 1 kΩ, 150 kΩ

**Terminator for RS-485:** 120 Ω

### Serial Communication Parameters

**Data Bits:** 5, 6, 7, 8  
**Stop Bits:** 1, 1.5, 2  
**Parity:** None, Even, Odd, Space, Mark  
**Flow Control:** RTS/CTS and DTR/DSR (RS-232 only), XON/XOFF  
**Baudrate:** Supports standard baudrates (unit=bps):  
 50, 75, 110, 134, 150, 300, 600, 1200, 1800, 2400, 4800, 7200, 9600,  
 19200, 38400, 57600, 115200, 230.4k, 460.8k, 921.6k

### Serial Signals

**RS-232:** Tx+, Rx+, RTS, CTS, DTR, DSR, DCD, GND  
**RS-422:** Tx+, Tx-, Rx+, Rx-, GND  
**RS-485-4w:** Tx+, Tx-, Rx+, Rx-, GND  
**RS-485-2w:** Data+, Data-, GND

### Software

**Network Protocols:** ICMP, IPv4, TCP, UDP, DHCP, BOOTP, Telnet, DNS, SNMP V1, HTTP, SMTP, SNTIP, Rtelnet, ARP  
**Configuration Options:** Web Console, Telnet Console, Windows Utility  
**Windows Real COM Drivers:** Windows 95/98/ME/NT/2000, Windows XP/2003/Vista/2008/7/8/8.1/10 (x86/x64), Windows 2008 R2/2012/2012 R2 (x64), Windows Embedded CE 5.0/6.0, Windows XP Embedded

**Fixed TTY Drivers:** SCO Unix, SCO OpenServer, UnixWare 7, QNX 4.25, QNX 6, Solaris 10, FreeBSD, AIX 5.x, HP-UX 11i, Mac OS X

**Linux Real TTY Drivers:** Linux 2.4.x, 2.6.x, 3.x, 4.x

**Android API:** Android 3.1.x and later

**Mini Screen with Push Buttons** (for standard temp. models)

**LCD Panel:** Liquid Crystal Display on the case

**Push Buttons:** Four push buttons for convenient on-site configuration

### Physical Characteristics

**Housing:** Metal

**Weight:** 740 g (1.63 lb)

### Dimensions:

Without mounting kit: 158 x 103 x 33 mm (6.22 x 4.06 x 1.30 in)

With mounting kit: 181 x 103 x 33 mm (7.14 x 4.06 x 1.30 in)

### Environmental Limits

#### Operating Temperature:

Standard Models: 0 to 55°C (32 to 131°F)

Wide Temp. Models: -40 to 75°C (-40 to 167°F)

**Storage Temperature:** -40 to 75°C (-40 to 167°F)

**Ambient Relative Humidity:** 5 to 95% (non-condensing)

### Power Requirements

**Input Voltage:** 12 to 48 VDC

#### Input Current:

NPort 5410: 350 mA @ 12 VDC

NPort 5430: 320 mA @ 12 VDC

NPort 5430I: 530 mA @ 12 VDC

NPort 5450/5450-T: 350 mA @ 12 VDC

NPort 5450I/5450I-T: 554 mA @ 12 VDC

### Standards and Certifications

**Safety:** UL 60950-1

**EMC:** EN 55032/24

**EMI:** CISPR 32, FCC Part 15B Class A

#### EMS:

IEC 61000-4-2 ESD: Contact: 4 kV; Air: 8 kV

IEC 61000-4-3 RS: 80 MHz to 1 GHz: 3 V/m

IEC 61000-4-4 EFT: Power: 1 kV; Signal: 0.5 kV

IEC 61000-4-5 Surge: Power: 1 kV; Signal: 1 kV

IEC 61000-4-6 CS: 150 kHz to 80 MHz: 3 V/m; Signal: 3 V/m

IEC 61000-4-8 PFMF

IEC 61000-4-11 DIPs

**Marine:** DNV (standard temp. models only)

**Medical:** EN 60601-1-2 Class B, EN 55011 (NPort 5410/5450/5450I only)

### Reliability

**Alert Tools:** Built-in buzzer and RTC (real-time clock)  
**Automatic Reboot Trigger:** Built-in WDT (watchdog timer)  
**MTBF** (mean time between failures)

**Time:**

NPort 5410: 310,331 hrs  
 NPort 5430/5430I: 265,650 hrs  
 NPort 5450/5450I: 206,903 hrs

**Standard:** Telcordia (Bellcore) Standard TR/SR

### Warranty

**Warranty Period:** 5 years  
**Details:** See [www.moxa.com/warranty](http://www.moxa.com/warranty)

### Dimensions

Unit: mm (inch)

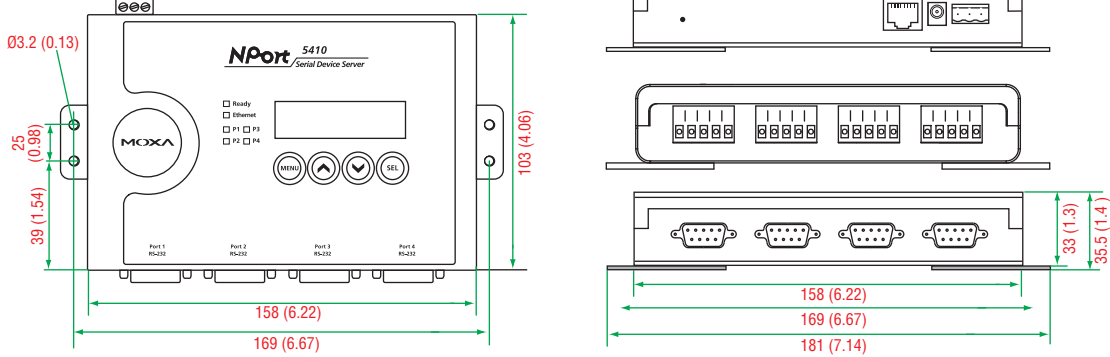

### Pin Assignment

**NPort® 5410**  
 (RS-232, DB9 male connector)

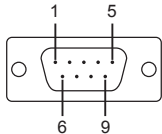

PIN	RS-232
1	DCD
2	RxD
3	TxD
4	DTR
5	GND
6	DSR
7	RTS
8	CTS
9	-

**NPort® 5430/5430I**  
 (RS-422/485, terminal block connector)

**NPort 5430/5430I**  
 Terminal Block

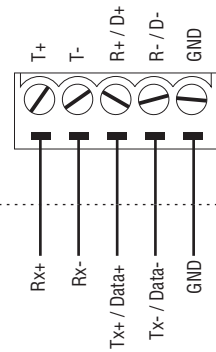

**NPort® 5450/5450I/5450-T/5450I-T**  
 (RS-232/422/485, DB9 male connector)

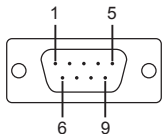

PIN	RS-232	RS-422/RS-485-4w	RS-485-2w
1	DCD	TxD-(A)	-
2	RxD	TxD+(B)	-
3	TxD	RxD+(B)	Data+(B)
4	DTR	RxD-(A)	Data-(A)
5	GND	GND	GND
6	DSR	-	-
7	RTS	-	-
8	CTS	-	-

## Ordering Information

### Available Models

- NPort 5410:** 4-port RS-232 device server
- NPort 5430:** 4-port RS-422/485 device server
- NPort 5430I:** 4-port RS-422/485 device server with 2 kV isolation protection
- NPort 5450:** 4-port RS-232/422/485 device server
- NPort 5450I:** 4-port RS-232/422/485 device server with 2 kV isolation protection
- NPort 5450-T:** 4-port RS-232/422/485 device server, -40 to 75°C operating temperature (without LCM)
- NPort 5450I-T:** 4-port RS-232/422/485 device server with 2 kV isolation protection, -40 to 75°C operating temperature (without LCM)

### Optional Accessories (can be purchased separately)

- DK35A:** DIN-rail mounting clips, 35 mm, 2 DIN-rail plates with 4 screws
- CBL-PJT10:** Non-locking barrel plug to bare wires cable
- Mini DB9F-to-TB:** DB9 female to terminal block adapter for RS-422/485 applications

**Note:** Additional power adapters can be purchased separately. Please refer to the Power Accessory Selection Guide for details.

### Package Checklist

- 1 NPort 5400 device server
- 1 power wiring adapter: CBL-PJT10
- Documentation and software CD
- Quick installation guide (printed)
- Warranty card

# Power Accessory Selection Guide

Barrel Plug Type		Locking Barrel Plug				
O/P		12 VDC 0.5 A, 100 to 240 VAC (Switch-Mode)				
Plug Type		US/JP	EU	AU	UK	CN
Appearance						
Model Name		PWR-12050-WPUSJP-S1	PWR-12050-WPEU-S1	PWR-12050-WPAU-S1	PWR-12050-WPUK-S1	PWR-12050-WPCN-S1
1 Port	NPort 5110	-	-	-	-	-
	NPort 5130	-	-	-	-	-
	NPort 5150	-	-	-	-	-
	NPort 5110A	✓	✓	✓	✓	✓
	NPort 5130A	✓	✓	✓	✓	✓
	NPort 5150A	✓	✓	✓	✓	✓
	DE-211	-	-	-	-	-
	DE-311	-	-	-	-	-
	NPort P5150A	✓	✓	✓	✓	✓
	NPort W2150A	✓	✓	✓	✓	✓
NPort Z2150/Z3150	✓	✓	✓	✓	✓	
2 Ports	NPort 5210	-	-	-	-	-
	NPort 5230	-	-	-	-	-
	NPort 5232	-	-	-	-	-
	NPort 5232I	-	-	-	-	-
	NPort 5210A	✓	✓	✓	✓	✓
	NPort 5230A	✓	✓	✓	✓	✓
	NPort 5250A	✓	✓	✓	✓	✓
	NPort W2250A	✓	✓	✓	✓	✓

Barrel Plug Type		Non-Locking Barrel Plug				
O/P		12 VDC 0.5 A, 100 to 240 VAC (Switch-Mode)				
Plug Type		US/JP	EU	AU	UK	CN
Appearance						
Model Name		PWR-12050-WPUSJP-S2	PWR-12050-WPEU-S2	PWR-12050-WPAU-S2	PWR-12050-WPUK-S2	PWR-12050-WPCN-S2
1 Port	NPort 5110	✓	✓	✓	✓	✓
	NPort 5130	✓	✓	✓	✓	✓
	NPort 5150	✓	✓	✓	✓	✓
	NPort 5110A	-	-	-	-	-
	NPort 5130A	-	-	-	-	-
	NPort 5150A	-	-	-	-	-
	DE-211	✓	✓	✓	✓	✓
	DE-311	✓	✓	✓	✓	✓
	NPort P5150A	-	-	-	-	-
	NPort W2150A	-	-	-	-	-
NPort Z2150/Z3150	-	-	-	-	-	
2 Ports	NPort 5210	✓	✓	✓	✓	✓
	NPort 5230	✓	✓	✓	✓	✓
	NPort 5232	✓	✓	✓	✓	✓
	NPort 5232I	✓	✓	✓	✓	✓
	NPort 5210A	-	-	-	-	-
	NPort 5230A	-	-	-	-	-
	NPort 5250A	-	-	-	-	-
	NPort W2250A	-	-	-	-	-

# Power Accessory Selection Guide

Barrel Plug Type		Non-Locking Barrel Plug				
O/P		12 VDC 1.25/1.5 A, 100 to 240 VAC				
Plug Type		US/JP	EU	AU	UK	CN
Appearance						
Model Name		PWR-12125-WPUSJP-S1	PWR-12125-WPEU-S1	PWR-12125-WPAU-S1	PWR-12125-WPUK-S1	PWR-12125-WPCN-S1
4 Ports	NPort 5410	✓	✓	✓	✓	✓
	NPort 5430	✓	✓	✓	✓	✓
	NPort 5430I	✓	✓	✓	✓	✓
	NPort 5450	✓	✓	✓	✓	✓
	NPort 5450I	✓	✓	✓	✓	✓
8 Ports	NPort 5610-8	-	-	-	-	-
	NPort 5630-8	-	-	-	-	-
	NPort 5650-8	-	-	-	-	-
	NPort 5650-8-M-SC	-	-	-	-	-
	NPort 5650-8-S-SC	-	-	-	-	-
	NPort 5610-8-DT	-	-	-	-	-
	NPort 5610-8-DT-J	-	-	-	-	-
	NPort 5650-8-DT	-	-	-	-	-
	NPort 5650-8-DT-J	-	-	-	-	-
	NPort 5650I-8-DT	-	-	-	-	-
NPort 5610-8-DTL	-	-	-	-	-	
16 Ports	NPort 5610-16	-	-	-	-	-
	NPort 5630-16	-	-	-	-	-
	NPort 5650-16	-	-	-	-	-

Barrel Plug Type		Locking Barrel Plug						
O/P		12 VDC 2 A, 100 to 240 VAC (desktop type)	10A/250V Power Cord, 183 cm					
Plug Type		Requires 1 power cord (US/JP/EU/AU/UK/CN)	US	JP	EU	AU	UK	CN
Appearance								
Model Name		PWR-12200-DT-S1	PWC-C13US-3B-183	PWC-C13JP-3B-183	PWC-C13EU-3B-183	PWC-C13AU-3B-183	PWC-C13UK-3B-183	PWC-C13CN-3B-183
4 Ports	NPort 5410	-	-	-	-	-	-	-
	NPort 5430	-	-	-	-	-	-	-
	NPort 5430I	-	-	-	-	-	-	-
	NPort 5450	-	-	-	-	-	-	-
	NPort 5450I	-	-	-	-	-	-	-
8 Ports	NPort 5610-8	-	✓	✓	✓	✓	✓	✓
	NPort 5630-8	-	✓	✓	✓	✓	✓	✓
	NPort 5650-8	-	✓	✓	✓	✓	✓	✓
	NPort 5650-8-M-SC	-	✓	✓	✓	✓	✓	✓
	NPort 5650-8-S-SC	-	✓	✓	✓	✓	✓	✓
	NPort 5610-8-DT	✓	✓	✓	✓	✓	✓	✓
	NPort 5610-8-DT-J	✓	✓	✓	✓	✓	✓	✓
	NPort 5650-8-DT	✓	✓	✓	✓	✓	✓	✓
	NPort 5650-8-DT-J	✓	✓	✓	✓	✓	✓	✓
	NPort 5650I-8-DT	✓	✓	✓	✓	✓	✓	✓
NPort 5610-8-DTL	✓	✓	✓	✓	✓	✓	✓	
16 Ports	NPort 5610-16	-	✓	✓	✓	✓	✓	✓
	NPort 5630-16	-	✓	✓	✓	✓	✓	✓
	NPort 5650-16	-	✓	✓	✓	✓	✓	✓